

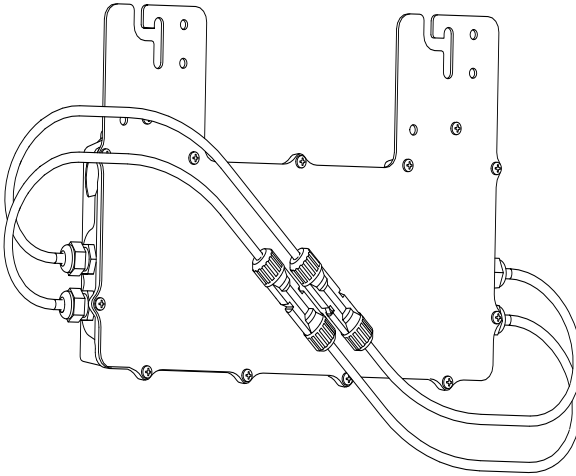

Installation Manual

Generac PV Link™ and SnapRS™



010023

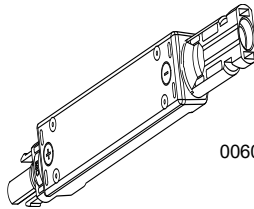

006087



WARNING

Loss of life. This product is not intended to be used in a critical life support application. Failure to adhere to this warning could result in death or serious injury. (000209b)

Register your Generac product at:

<https://pwrfleet.generac.com>

1-888-GENERAC
(888-436-3722)

Para español, visita: <http://www.generac.com/service-support/product-support-lookup>

Pour le français, visiter: <http://www.generac.com/service-support/product-support-lookup>

SAVE THIS MANUAL FOR FUTURE REFERENCE

Use this page to record important information about your Generac Product

Record PV Link™ and SnapRS™ information for your PWRcell® system on this page.

When contacting a Generac Products Authorized Service Dealer (ASD) about parts and service, always supply complete model number and serial number information.

Operation and Maintenance: Proper maintenance and care of the energy storage system ensures a minimum number of problems and keeps operating expenses at a minimum. It is the operator's responsibility to perform all safety checks, to verify that all maintenance for safe operation is performed promptly, and to have the equipment checked periodically by an ASD. Normal maintenance, service and replacement of parts are the responsibility of the owner/operator and, as such, are not considered defects in materials or workmanship within the terms of the warranty. Individual operating habits and usage may contribute to the need for additional maintenance or service.

Table 1 : PV Link and SnapRS Important Information

PV Link Number	Location	Serial Number	RCP Number	Parallel Input?	Number of SnapRS	SnapRS Date of Manufacture
1						
2						
3						
4						
5						
6						

 WARNING CANCER AND REPRODUCTIVE HARM www.P65Warnings.ca.gov <small>(000393a)</small>

Table of Contents

Section 1 Introduction and Safety 1

Introduction	1
Safety Rules	1
General Hazards	2
PVRSE Warning	2
Electrical Hazards	3

Section 2 General Information 5

PV Link Specifications	5
SnapRS Specifications	5
Important Product Information	6
Unit Dimensions	6
About PV Link	6
About Generac SnapRS	6
GFDI Information	6
AFCI Information	7
PVRSS Information	7
Component Locations	7

Section 3 Installation Design 9

Voltage Considerations	9
------------------------------	---

Section 4 PVRSS Compliance

Guidelines	11
-------------------------	-----------

Section 5 Mounting and

Connecting 13

Installation Guidelines	13
Attachment and Grounding	13
Connecting to Inverter	14
Connecting PV modules	14

Section 6 Operating Instructions 17

User Interface via Inverter	17
Commissioning PV Link	17
Commissioning with SnapRS Devices for PVRSS	17
Disabling PV Link	19
AFD Self-Test	19
PVRSS Self-Test	19

Section 7 Maintenance 21

Maintenance	21
Service	21

Section 8 Troubleshooting 23

This page intentionally left blank.

Section 1 Introduction and Safety

Introduction

Thank you for purchasing a Generac PWRcell® product.

This manual provides instructions for installing PV Link and SnapRS devices. Consult the installation and operation manuals for other Generac PWRcell system components, as applicable.

The information in this manual is accurate based on products produced at the time of publication. The manufacturer reserves the right to make technical updates, corrections, and product revisions at any time without notice.



⚠️ WARNING

Consult Manual. Read and understand manual completely before using product. Failure to completely understand manual and product could result in death or serious injury. (000100a)

If any section of this manual is not understood, contact the nearest Independent Authorized Service Dealer (IASD) or Generac Customer Service at 1-888-436-3722 (1-888-GENERAC), or visit www.generac.com for assistance. The owner is responsible for correct maintenance and safe use of the unit.

This manual must be used in conjunction with all other supporting product documentation supplied with the product.

SAVE THESE INSTRUCTIONS for future reference. This manual contains important instructions that must be followed during placement, operation, and maintenance of the unit and its components. Always supply this manual to any individual that will use this unit, and instruct them on how to correctly start, operate, and stop the unit in case of emergency.

Safety Rules

The manufacturer cannot anticipate every possible circumstance that might involve a hazard. The alerts in this manual, and on tags and decals affixed to the unit, are not all inclusive. If using a procedure, work method, or operating technique that the manufacturer does not specifically recommend, verify that it is safe for others and does not render the equipment unsafe.

Throughout this publication, and on tags and decals affixed to the unit, DANGER, WARNING, CAUTION, and NOTE blocks are used to alert personnel to special instructions about a particular operation that may be hazardous if performed incorrectly or carelessly. Observe them carefully. Alert definitions are as follows:

⚠️ DANGER

Indicates a hazardous situation which, if not avoided, will result in death or serious injury.

(000001)

⚠️ WARNING

Indicates a hazardous situation which, if not avoided, could result in death or serious injury.

(000002)

⚠️ CAUTION

Indicates a hazardous situation which, if not avoided, could result in minor or moderate injury.

(000003)

NOTE: Notes contain additional information important to a procedure and will be found within the regular text of this manual.

These safety alerts cannot eliminate the hazards that they indicate. Common sense and strict compliance with the special instructions while performing the action or service are essential to preventing accidents.

How to Obtain Service

For assistance, contact the nearest Independent Authorized Service Dealer (IASD) or Generac Customer Service at 1-888-GENERAC (1-888-436-3722), or visit www.generac.com.

When contacting Generac Customer Service, always supply the complete model and serial number of the unit as given on its data decal located on the unit. Record the model and serial numbers in the spaces provided on the front cover of this manual.

General Hazards

⚠ DANGER

Automatic start-up. Disconnect utility power and render unit inoperable before working on unit. Failure to do so will result in death or serious injury.

(000191)

⚠ WARNING

Risk of injury. Do not operate or service this machine if not fully alert. Fatigue can impair the ability to operate or service this equipment and could result in death or serious injury.

(000215a)



⚠ WARNING

Loss of life. This product is not intended to be used in a critical life support application. Failure to adhere to this warning could result in death or serious injury.

(000209b)

⚠ WARNING

Hot surfaces. Locate and install the PV Link so as to avoid inadvertent contact. When operating in hot weather the optimizer will become hot and could result in personal injury.

(000670)

⚠ WARNING

Electric shock. Only a trained and licensed electrician should perform wiring and connections to unit. Failure to follow proper installation requirements could result in death, serious injury, and equipment or property damage.

(000155a)

⚠ WARNING

Equipment damage. Only qualified service personnel may install, operate, and maintain this equipment. Failure to follow proper installation requirements could result in death, serious injury, and equipment or property damage.

(000182a)

⚠ CAUTION

Equipment damage. Never open the PV Link. The optimizer is factory-sealed and contains no field serviceable parts. Opening the optimizer could result in equipment damage.

(000655a)

⚠ CAUTION

Equipment damage. Never operate PV Link in ambient temperatures greater than 158 °F (70 °C). Doing so will result in equipment damage.

(000669a)

⚠ CAUTION

Equipment damage. Connect only to REBus-compatible devices to the DC bus. Never connect to any other DC power source. Connecting to other DC power sources could result in equipment damage.

(000598a)

- Connecting Generac PWRcell to the electric utility grid must only be done after receiving prior approval from the utility company.
- Only competent, qualified personnel should install, operate, and service this equipment. Strictly comply to local, state, and national electrical and building codes. When using this equipment, comply with regulations established by the National Electrical Code (NEC), CSA Standard; the Occupational Safety and Health Administration (OSHA), or the local agency for workplace health and safety.
- Protection against lightning surges in accordance with local electric codes is the responsibility of the installer.

NOTE: Lightning damage is not covered by warranty.

- If working on this equipment while standing on metal or concrete, place insulative mats over a dry wood platform. Work on this equipment only while standing on such insulative mats.
- Never work on this equipment while physically or mentally fatigued.
- Any voltage measurements should be performed with a meter that meets UL3111 safety standards, and meets or exceeds overvoltage class CAT III.

PVRSE Warning

NOTE: SnapRS devices must be used in conjunction with Generac S2502 PV link to form a complete PVRSS per NEC 690.12

This Photovoltaic Rapid Shutdown Equipment (PVRSE) does not perform all of the functions of a complete Photovoltaic Rapid Shutdown System (PVRSS). This PVRSE must be installed with other equipment to form a complete PVRSS that meets the requirements of NEC (NFPA 70) section 690.12 for controlled conductors outside the array. Other equipment installed in or on this PV system may adversely affect the operation of the PVRSS. It is the responsibility of the installer to ensure the completed PV system meets the rapid shutdown functional requirements. This equipment must be installed according to the manufacturer's installation instructions.

Electrical Hazards



⚠ DANGER

Electrocution. Water contact with a power source, if not avoided, will result in death or serious injury.

(000104)



⚠ DANGER

Electrocution. In the event of electrical accident, immediately shut power OFF. Use non-conductive implements to free victim from live conductor. Apply first aid and get medical help. Failure to do so will result in death or serious injury.

(000145)



⚠ DANGER

Electrocution. Turn battery disconnect OFF and de-energize REBus before touching terminals. Failure to do so will result in death, serious injury, equipment and property damage.

(000599)



⚠ DANGER

Electrocution. Verify electrical system is properly grounded before applying power. Failure to do so will result in death or serious injury.

(000152)



⚠ DANGER

Electrocution. Do not wear jewelry while working on this equipment. Doing so will result in death or serious injury.

(000188)



⚠ DANGER

Electric shock. Avoid contact with DC conductors. DC conductors of this photovoltaic system are ungrounded and may be energized regardless of sun exposure. Contact with conductors will result in death or serious injury.

(000666a)



⚠ WARNING

Electrocution. Potentially lethal voltages are generated by this equipment. Render the equipment safe before attempting repairs or maintenance. Failure to do so could result in death or serious injury.

(000187)

This page intentionally left blank.

Section 2 General Information

PV Link Specifications

Description	Units	S2502
Rated power	W	2,500 (continuous)
Peak efficiency	%	99
MPPT input voltage	VDC	60 – 360
Rated power input voltage	VDC	200 – 360
Maximum input voltage	VDC	420 (absolute maximum)
Maximum input current (operating)	A °F (°C)	13 @ 122 (50)
Maximum input current (short circuit)	A	18
Maximum output current (fault)	A	10
Maximum output voltage	VDC	420 (open circuit)
Nominal output	-	REbus DC nanogrid (380 VDC + data)
Maximum output current (continuous)	A	8
Standby power	W	<1
Topology	-	Boost converter
Protections	-	Ground-fault protection, arc-fault protection (type 1), PVRSE
Operating temperature range	°F (°C)	-40 (-40) to 158 (70)
Enclosure	-	UL Type 4X
Weight	lb (kg)	7.3 (3.3)
Certifications	-	UL 1741, UL 1699B, CSA 22.2 #107.1

Specifications are subject to change without notice. Refer to the product specification sheet for complete list.

SnapRS Specifications

Description	Units	RS801	RS801A	RS802
PV Module maximum VOC	V	75	80	80
Maximum number of PV modules per substring	-	10*		
Typical power loss at maximum input current	W	1.3	1.33	1.35
Maximum input current	A	13	14	15
Max STC ISC of string	A	10.4	11.2	12
Shutdown time	Sec	< 10		
Enclosure rating	-	NEMA Type 6P		
Operating temperature range	°F (°C)	-40 (-40) to 158 (70)		
Certifications	-	UL 1741, CSA 22.2 #107.1		
Weight	oz (g)	2.7 (76.5)		

* 1 SnapRS per PV Module.

Important Product Information

PV Link Serial Number Location

See [Figure 2-1](#). Serial number tag (A) includes a removable layer that can be peeled off leaving the underlying label in place. Adhere the removable layer to the inside cover of this manual and record the information from this tag in [Table 1 : PV Link and SnapRS Important Information](#).

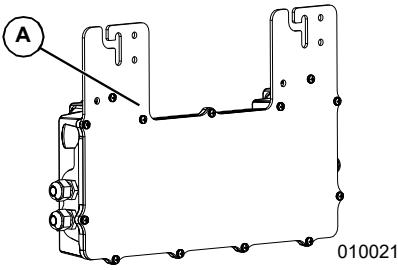

Figure 2-1. Serial Number Location

Unit Dimensions

PV Link Dimensions

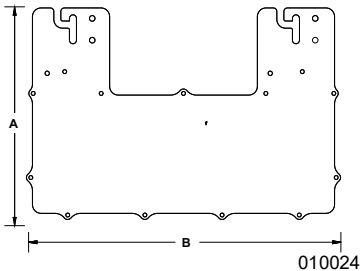

Figure 2-2. Unit Dimensions

A	9-9/16 in (243 mm)
B*	15-1/2 in (390 mm)
C	2-1/16 in (53 mm)

*18-1/8 in (460 mm) with PV wire bend radius

SnapRS Dimensions

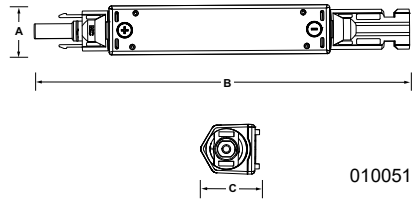

Figure 2-3. Unit Dimensions

A	7/8 in (22 mm)
B	7 in (178 mm)
C	1 in (25 mm)

About PV Link

The PV Link is a nonisolated, interleaved DC-DC converter that boosts PV input to a higher voltage and outputs it to REbus™, Generac's regulated 380 VDC bus. The PV Link provides droop-mode power management, enabling multiple optimizers to connect in parallel on a common bus. Its DC output carries a bidirectional power line communication (PLC) protocol for communicating with inverters and other devices on REbus.

PV Link is intended for use with 60-cell, 72-cell, or 96-cell residential DC PV modules. PV modules must not require positive or negative grounding as this would interfere with PLC communications.

NOTE: Other PV modules may be suitable for use with PV Link, contact Generac for more information.

The PV Link is sealed in a type 4X enclosure at the factory and is designed for attachment to standard PV racking. Safety features include ground fault detection and interruption (GFDI), arc fault detection, circuit interruption (AFCI), and rapid shutdown capability.

About Generac SnapRS

SnapRS is an inline PV Rapid Shutdown device that satisfies 2017 and 2020 NEC 690.12 PV Rapid Shutdown system (PVRSS) requirements. When used with PV Link, SnapRS devices limit all controlled conductors within an array's 1 ft (305 mm) boundary to 80 VDC or less within 30 seconds of rapid shutdown initiation.

GFDI Information

The PV Link's internal ground fault detector and interrupter (GFDI) is designed to trip at 240 mA (\pm 40 mA) of PV DC voltage ground current. Ground faults are displayed on the

PWRcell Inverter control Panel. The PV Link meets the ground fault protection requirements in NEC Article 690.41(B).

AFCI Information

The PV Link is a Photovoltaic DC Arc Fault Circuit Protection Type 1 device that incorporates an internal arc fault circuit interrupter (AFCI) and meets the arc fault circuit protection requirement in NEC Article 690.11.

PVRSS Information

PV Rapid Shutdown system (PVRSS) requirements have evolved over time and are defined by the National Electrical Code (NEC) in conjunction with UL 1741. Determine what level of PV Rapid Shutdown is required for your jurisdiction.

- The 2011 NEC and older editions do not require PVRSS capability.
- The 2014 NEC requires rapid shutdown only on the conductors leaving the PV array.
- The 2017 and 2020 NEC require rapid shutdown at the PV module level and on the conductors leaving array.

PV Link is a PV Rapid Shutdown system equipment (PVRSE) component within a PVRSS. It provides rapid shutdown for the conductors leaving the array. SnapRS devices are required for PV Module level rapid shutdown within the array. See [PVRSS Compliance Guidelines](#) for more information.

Component Locations

PV Link Component Locations

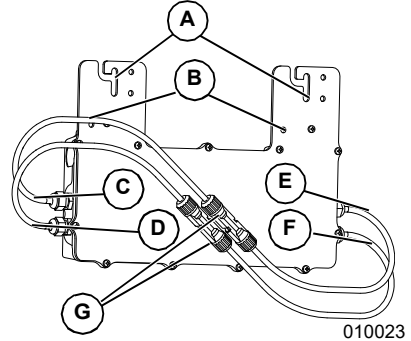

Figure 2-4. Component Locations

- A** Attachment Flange Slots
- B** Grounding Terminals (sized for 1/4 in hardware)
- C** REBus DC Nanogrid Output Negative (-) Lead
- D** REBus DC Nanogrid Output Positive (+) Lead
- E** PV Substring Input Negative (-) Lead
- F** PV Substring Input Positive (+) Lead
- G** MC4 Connectors

SnapRS Component Locations

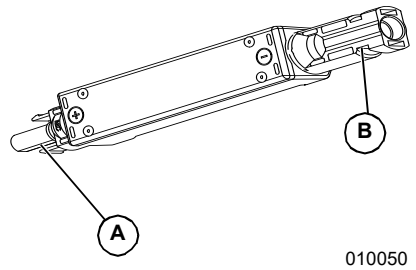

Figure 2-5. Component Locations

- A** Positive PV Connector
- B** Negative PV Connector

This page intentionally left blank.

Section 3 Installation Design

Voltage Considerations

Use the formulas in this section to determine the maximum number of PV modules of a given type that can be connected to a PV Link. For more detailed information on array sizing visit www.generac.com.

NOTE: Fewer PV modules may be used providing the minimum MPPT input voltage is satisfied.

1. Use Equation (1) to calculate the Adjusted Module Voc for the chosen PV Module. Reference [Table 3-1: NEC Cold Factor](#).

NOTE: The temperature correction factor listed on the module nameplate can be used as a substitute for the NEC Cold Factor if available.

$$\text{Module } V_{OC} \times \text{NEC Cold Factor} = \text{Adjusted Module } V_{OC}$$

013760

Figure 3-1. Equation 1

Table 3-1. NEC Cold Factor

Minimum Temperature (°F)	NEC Cold Factor	Minimum Temperature (°C)
49 to 41	1.08	9 to 5
40 to 32	1.10	4 to 0
31 to 23	1.12	-1 to -5
22 to 14	1.14	-6 to -10
13 to 5	1.16	-11 to -15
4 to -4	1.18	-16 to -20
-5 to -13	1.20	-21 to -25
-14 to -22	1.21	-26 to -30
-23 to -31	1.23	-31 to -35
-32 and below	1.25	-36 and below

2. Use equation (2) to determine the Max Number of Modules Voc, where PV Link Max Voc = 420 VDC.

$$\frac{\text{PV Link Max } V_{OC}}{\text{Module } V_{OC}} = \text{Max Number of Modules}_{voc}$$

013761

Figure 3-2. Equation 2

3. Use Equation (3) to determine the Max Number of Modules Vmp, where PV Link Max Vmp = 360 VDC.

$$\frac{\text{PV Link Max } V_{mp}}{\text{Module } V_{mp}} = \text{Max Number of Modules}_{vmp}$$

013762

Figure 3-3. Equation 3

4. Compare the results from Step 2 and Step 3 and choose the smaller number. Round down to the nearest integer. Record this

This page intentionally left blank.

Section 4 PVRSS Compliance Guidelines

2011 NEC and Older Editions

2011 NEC and older editions do not require PVRSS compliance.

NOTE: The PV Link will still provide 2014 NEC compliant PV Rapid Shutdown.

2014 NEC

The 2014 NEC 690.12 introduced a new requirement for PV systems that is commonly referred to as PV Rapid Shutdown.

To meet 2014 NEC compliance:

1. Install the PWRcell Inverter as specified in the **Generac PWRcell Inverter Installation Manual and Owner's Manual**.
2. Install the PV Link as specified in this manual.
3. The DC disconnect under the PWRcell Inverter front cover labeled PV by the installer can be used as the PVRSS initiation device. See Rapid Shutdown in the **Generac PWRcell Inverter Installation and Owner's Manual** for more information.
4. The Remote STOP terminals in the PWRcell Inverter wiring compartment labeled "STOP" can be used for PVRSS initiation. If the PWRcell system includes PWRcell Battery/ies, the battery/ies must have a battery management unit (BMU) with optional STOP terminal hardware. See Generac PWRcell Battery Installation and Owner's Manual for instructions. An external actuator must be provided by the installer. Appropriate signage, in compliance with the NEC must be provided by the installer indicating the function of the external actuator.

Rapid shutdown response time is less than 10 seconds.

2017 and 2020 NEC

The 2017 and 2020 NEC have PVRSS requirements mandating the need to reduce voltages of controlled conductors to less than 80 VDC within the array, and less than 30 VDC outside the array, as well as some specification for the location of the PVRSS initiator and its labeling.

To meet 2017 and 2020 compliance:

1. The 2017 and 2020 NEC requires the PVRSS initiator be located at a readily accessible location outside the building.
 - The DC disconnect under the PWRcell Inverter front cover labeled PV by the installer can be used as the PVRSS initiation device.
 - An external actuator, connected by the installer to the PWRcell Inverter's STOP terminals can be used as the PVRSS initiation device. If the PWRcell system includes PWRcell Battery/ies, the battery/ies must have a battery management unit (BMU) with STOP terminal hardware. See Generac PWRcell Battery Installation and Owner's Manual for instructions.

NOTE: Provide signage indicating the PVRSS initiation device is the REbus PV DC disconnect located under the front cover of the inverter, or the external actuator connected to the STOP terminals.

- An externally mounted PVRSS initiation device is required to be installed at a readily accessible location when the PWRcell Inverter is installed within a one- or two-family dwelling unit.

NOTE: Provide signage indicating where PVRSS initiation devices are located. Note that if the inverter is installed in the appropriate outdoor location it may satisfy this requirement.

2. Provide signage complying with section 690.56(C) of the NEC (NFPA 70), stating all conductors are controlled.

NOTE: Install one SnapRS to the negative whip (-) of each PV Module connected to the PV Link.

3. Install the PV Link. See **Installation Guidelines** for more information.

Upon initiation of rapid shutdown PV Link and SnapRS will meet or exceed NEC requirements and control voltage with a response time of less than 10 seconds. Voltage within the array is controlled to no greater 80 VDC and voltage outside the array is controlled to no greater than 30 VDC.

This page intentionally left blank.

Section 5 Mounting and Connecting

Installation Guidelines

WARNING

Hot surfaces. Locate and install the PV Link so as to avoid inadvertent contact. When operating in hot weather the optimizer will become hot and could result in personal injury.

(000670)

- Install PV Links close to the edge of the array for best cooling and easier service access.
- Calculate maximum substring length using the [Voltage Considerations](#) in [Section 3 Installation Design](#) of this manual.
- The modules within each substring must be the same type, and all should be mounted at the same tilt and azimuth for optimal performance.
- When installing a system with multiple PV Links, it is not necessary to match the number of modules, roof pitch, or azimuth across all substrings in an array.
- Ensure at least a 1 in (25.4 mm) clearance between the heatsink fins and adjacent surfaces to allow sufficient air flow for cooling.
- The PV Link can be installed in any orientation. Cooling is most effective if fins are oriented vertically and facing away from the PV module.
- Mount the optimizer at least 3 ft (0.9 m) from the ground.
- Review the PV module instructions to determine if any restrictions for mounting devices under the module exist as part of the PV module listing.

Attachment and Grounding

CAUTION

Equipment damage. Never leave the PV Link MC4 connectors open and exposed to the atmosphere overnight or during rain. Doing so could cause equipment failure.

(000657)

NOTE: Proper grounding is necessary for REBus communication.

Installing to Metallic or Grounded Structures

See [Figure 5-2](#). If mounting PV Link underneath an array to metallic PV racking, install the PV Link with label (A) facing up. Attachment flange slots (B) accept fasteners up to M8 or 5/16 in diameter.

Installing to a Grounded Rail

- See [Figure 5-1](#). Use two rail-compatible fasteners (D) to secure the PV Link to the grounded rail.

- Use a grounding washer (E) between the rail and attachment flange to penetrate the rail's anodized coating.
- Torque fasteners according to the clip manufacturer's instructions.

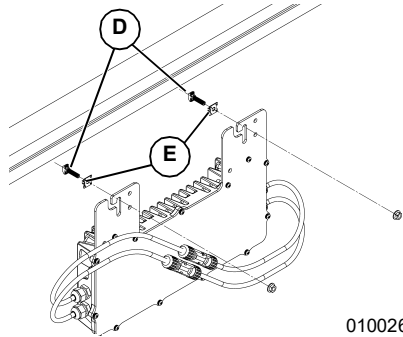

010026

Figure 5-1. Attaching to a Grounded Metal Rail

Installing to Nonmetallic or Ungrounded Structures

- Use two fasteners appropriate for the structure.
- See [Figure 5-2](#). Fasten the equipment grounding conductor to grounding terminal (C) using a field supplied lug.
- Use listed bonding hardware only.
- Size equipment grounding conductor per NEC requirements and torque per manufacturer specifications.

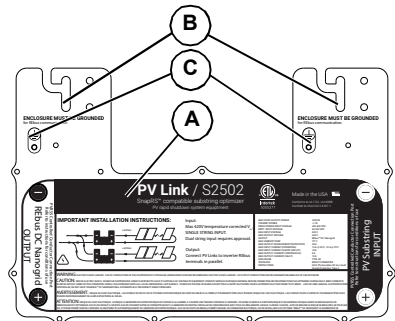

010025

Figure 5-2. Grounding Terminal Location

Installing to Rail-less Racking

1. Select mounting structures that allow for PV Link to be installed adhering to installation guidelines.
2. See [Figure 5-3](#). Use two fasteners compatible with the mounting structure.

3. See [Figure 5-2](#). Fasten the equipment grounding conductor to grounding terminal (C) using a field supplied lug.

NOTE: For PV Link model S2502, attachment flange slots (B) may be widened using tooling, such as a drill and bit, where the rail-less racking mount bolt needs to fit for mounting.

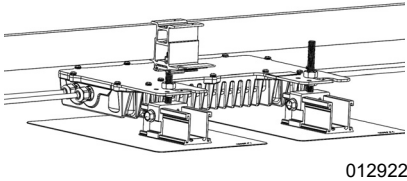

Figure 5-3. Installing to rail-less Racking

4. Use listed bonding hardware only.
5. Size equipment grounding conductor per NEC requirements and torque per manufacturer specifications.

Connecting to Inverter

⚠ CAUTION

Equipment damage. Connect the PV Link output to a REBus-compatible device (± 190 VDC nominal regulated DC bus) only. Connecting to conventional PV inverters or any other device could cause equipment damage. (000659)

See [Figure 5-4](#). Connect each PV Link output to the REBus DC nanogrid and inverter

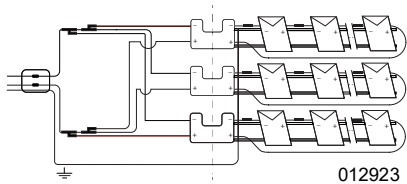

Figure 5-4. Connecting PV Link Optimizer

When connecting optimizers to the inverter:

- Do not reverse the input and output or cross-wire polarity. To avoid confusion, complete the wiring of the PV Link output before installing PV modules.
- Do not connect PV Link optimizers in series.
- Connect up to three PV Link outputs in parallel. To connect PV Links in parallel:
 - Connect all negative RE (-) PV Link outputs on a home run together.
 - Connect all positive RE (+) outputs on a home run together.
- Current adds when connecting optimizers in parallel. The maximum output current of each PV Link is 8 A. When wiring PV Link outputs to the inverter, observe temperature ratings and current-carrying capacity of

the wire used, including appropriate NEC derating factors.

NOTE: The maximum number of PV Links that may be wired in parallel back to the inverter is three.

NOTE: Multiple home-runs will be necessary in larger systems.

- Connect field wiring to the PV Link with Staubi MC4 PV connectors only.
- Mark positive REBus field wiring leads with red insulation or flagging.
- Mark negative REBus field wiring leads with blue insulation or flagging.
- Connect multiple optimizers in parallel, using MC4 branch connectors or a combiner box.

Connecting PV modules

⚠ CAUTION

Equipment damage. Never leave the PV Link MC4 connectors open and exposed to the atmosphere overnight or during rain. Doing so could cause equipment failure. (000657)

⚠ CAUTION

Equipment damage. Never connect PV Link to any other power source. The optimizer is designed to work with series connected PV modules only. Connecting the optimizer to any other power source could cause equipment damage. (000661)

NOTE: Warranty does not cover water ingress through wiring from external connections due to poor wiring practices.

2014 NEC and Earlier Editions

For NEC 2014 compliant systems, connect the substring PV modules in series.

NOTE: See [Figure 5-6](#). Not all PV modules can be wired in series to PV Link. Parallel series substrings are necessary for high voltage modules.

To install PV modules in series to PV Link:

1. Connect the negative lead of the first module in the string to the PV Link at the location marked PV Substring Input (-). See [Component Locations](#) for PV Input location.
2. Connect the first module's positive lead to the second module's negative lead.
3. Continue connecting the substring module leads in series until the last module is reached.
4. Connect the positive lead of the last module in the substring to the PV Link at the location marked PV Substring Input (+) using an appropriate field installed jumper as necessary. See [Component Locations](#) for PV input location.

-
5. Make a substring map using the serial number stickers and record in [Table 1 : PV Link and SnapRS Important Information](#) the following information:
 - Each PV Link serial number
 - Each PV Link RCP number
 - Number of substrings in parallel.

2017 and 2020 NEC Compliant Systems

For NEC 2017 and 2020 compliant systems, connect the substring PV modules in series using one SnapRS device in between each module.

Installing SnapRS Devices

The following important installation requirements should be adhered to for new and existing installations.

- Always ensure the number of SnapRS devices detected matches the physical number of SnapRS devices installed in a substring.
- Do not modify SnapRS counts to force PV Link operation.

Ensure all PV Links are operating on the latest firmware:

Generac has released, and will continue to release, over the-air firmware updates which implement important safety and product performance improvements. These firmware updates typically occur automatically, however installers should verify firmware is up to date. Generac strongly recommends a high-speed internet connection for all PWRcell systems.

SnapRS devices should not be installed in locations subject to continuous standing water:

SnapRS devices are manufactured with a robust NEMA 6P rating, however, continuous water submersion is not permitted and may lead to premature failure. U-channel racking, or confined raceways are prone to water intrusion and are not appropriate locations for SnapRS devices.

SnapRS devices should not be installed in locations that restrict airflow impeding convective cooling:

SnapRS devices are suitable for a wide range operational temperature (-40C to 70C), however, if installed in a confined space, operating temperature may increase significantly above the ambient temperature. It is recommended to suspend SnapRS devices from PV racking or module frames in open air to allow proper cooling and ventilation. Avoid placing mechanical stress on the MC4 connectors of the input/output of the SnapRS device.

SnapRS devices should not be installed in such a way that allows direct contact with the building or roofing materials:

Proper wire management is important to keep photovoltaic conductors and SnapRS devices suspended from the modules and racking. Conductors must be supported at intervals not to exceed 24 in following Article 690.31(C)(1) of the NEC. Failure to effectively manage conductors may result in damage to conductor insulation.

- Use PV cable clips or rated cable ties for the application (UV, exterior use).
- Allow 3 - 6 in on either side of SnapRS.

NOTE: Pre-install SnapRS devices to each PV modules negative (-) whip to ensure a 1:1 ratio.

When installing SnapRS devices consider the following:

- Each PV Link can control a connected substring of PV modules with a cumulative voltage between 60 – 420 VDC. For substring sizing guidance, see [Voltage Considerations](#).
- The positive (+) end of one (1) SnapRS device must be installed to the negative (-) lead of each PV Module in the array.
- PV modules require Staubli (Multi-Contact) MC4 connectors. Brands other than Staubli MC4 connectors are not recommended.

NOTE: MC4 connectors are not watertight unless mated. Never leave this system partially assembled.

- See [Figure 5-5](#). PV modules are installed in series with SnapRS devices connected inline between each module.
- See [Figure 5-6](#). High voltage modules can be configured using parallel substrings to the input of the PV Link.

NOTE: Install SnapRS devices prior to securing PV modules to the racking.

To install SnapRS devices:

1. See [Figure 5-5](#). For each PV Module in the PV string, connect the positive (+) end of one SnapRS device (C) to the negative (-) whip of the PV module (D).
2. Connect the negative (-) end of each SnapRS device to the positive (+) whip of the next PV module in the series.
3. Connect the PV substring positive lead to PV Link (B) at the location marked PV Substring Input + (F). See [Component Locations](#) for more information.
4. Connect the PV substring negative lead with its connected SnapRS device to PV Link (B) at the location marked PV Substring Input - (E). See [Component Locations](#) for more information.
5. Secure the SnapRS devices to the module frame or racking using PV cable clips or appropriately rated cable ties.

NOTE: When connecting the PV substring to the PV Link, the PV Link MC4 connector labeling will indicate the same polarity as the PV substring connector (ex. PV Link positive (+) will connect to the (+) whip of the first PV Module in the substring). This will also be true with SnapRS installed on the negative (-) whip. This is intentional and differs from the connection method for combining PV modules together with SnapRS.

6. Make a substring map using the PV Link peel-and-stick serial number stickers and record in **Table 1 : PV Link and SnapRS Important Information** the following information:
 - Each PV Link serial number
 - Each PV Link RCP number
 - Number of substrings in parallel
 - SnapRS devices per substring
 - SnapRS date of manufacture.

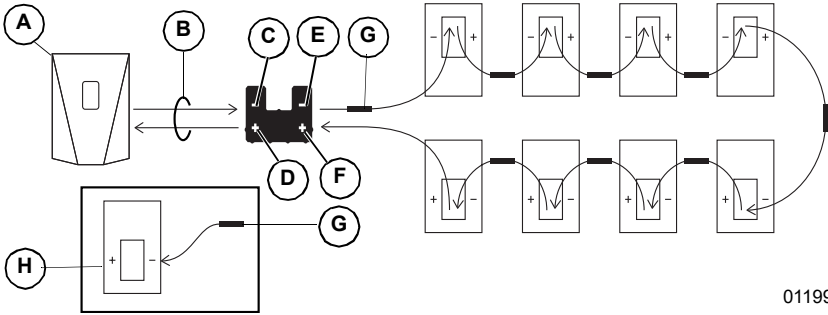

011990

Figure 5-5. Single PV Substring with SnapRS Devices

- | | |
|---------------------------|-------------------------------|
| A PWRcell Inverter | E PV Substring Input - |
| B Rebus Homerun | F PV Substring Input + |
| C Rebus Output - | G SnapRS Device |
| D REbus Output + | H PV Module |

NOTE: See **Figure 5-6**. When two smaller series substrings are connected in parallel for high voltage PV modules, each series substring must use the same number and type of PV modules, and there must be one SnapRS device for each module in the array. Additionally, the 'String Count' setting in Mod. Settings at the PV Link device page must be set to '2.'

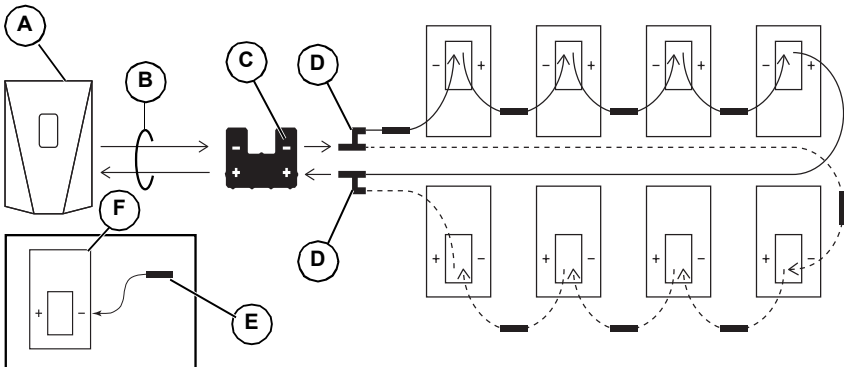

010029

Figure 5-6. Single PV Substring with Parallel Series Inputs and SnapRS Devices

- | | |
|---------------------------|-------------------------------|
| A PWRcell Inverter | D MC4 Branch Connector |
| B REbus Homerun | E SnapRS Device |
| C PV Link | F PV Module |

Section 6 Operating Instructions

User Interface via Inverter

PV Link Information and control features are available on the PWRcell Inverter control panel when REbus is energized. See the **Generac PWRcell Inverter Installation and Owner's Manual** for more information.

See **Figure 6-1**. To access the device page for each PV Link, use left or right arrow buttons (A) on the inverter control panel to scroll through the pages. When on a PV Link device page, press center button (B) to access the main menu and enable or disable the device or to modify settings. The disabled/enabled state does not affect communication with the inverter.

NOTE: The PV Link only produces power after the REbus DC nanogrid has been established and the device has been enabled.

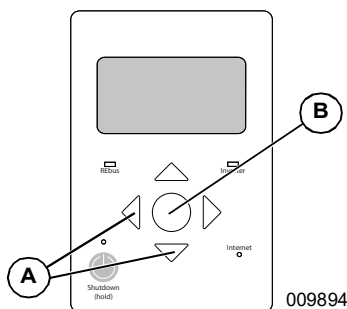

Figure 6-1. Inverter Control Panel

Commissioning PV Link

The PV Link ships from the factory in a disabled state. Each unit must be enabled from the PWRcell Inverter control panel. See **Table 1: PV Link Settings** for settings information. Once the inverter is enabled and REbus voltage is present at the PV Link, the PV Link will be able to communicate on the system. After properly enabling the PV Link, it will detect the REbus nanogrid and begin exporting power based on the system mode and settings selected.

See the **PWRcell Inverter Installation and Owner's Manual** for more information on system modes and commissioning.

To enable and commission PV Link:

- Ensure REbus +/- are connected with correct polarity to each PV Link.
- Ensure each PV Link has a low resistance ground connection to the inverter ground bar.
- Ensure PWRcell Inverter DC Disconnect(s) are in the ON position for each PV Link.

- Ensure inverter is enabled.

Commissioning with SnapRS Devices for PVRSS

NOTE: Before commissioning a PV Link record the number SnapRS devices physically installed on each PV Link.

To enable PV Link to work as a PVRSS with SnapRS devices:

1. Press the right arrow button on the control module until the PV Link device page appears.

NOTE: The device page should read Disabled. If it does not read Disabled, press the center button and disable the device.

2. Record the RCPn in **Table 1: PV Link and SnapRS Important Information**, found on the front cover of this manual.

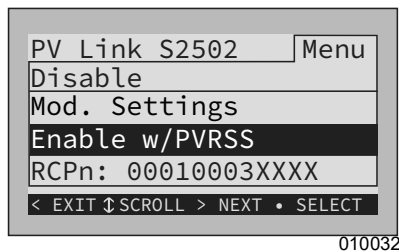

Figure 6-2. Enable w/PVRSS

3. See **Figure 6-2**. Press the center button and select Enable w/PVRSS to enter the Testing PVRSS state.
4. See **Figure 6-3**. Press the center button and select Mod. Settings to access device settings and options.
5. See **Figure 6-4**. If installing parallel series substrings for high voltage modules, select Mod. Settings and update the string count value to 2.

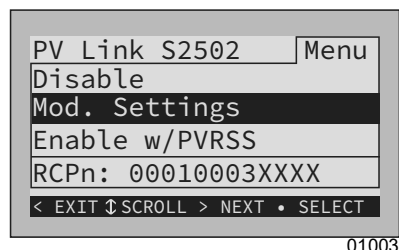
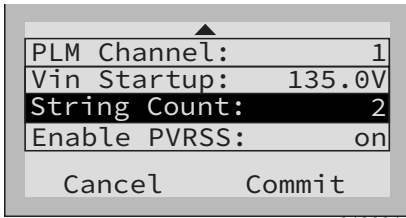

Figure 6-3. PVRSS Commissioning (1 of 4)



012924

Figure 6-4. PVRSS Commissioning (2 of 4)

- See [Figure 6-5](#). The LCD will display Testing PRVSS during the testing process. Upon completion, the LCD will read Low Sun or Making Power, depending upon available PV voltage.

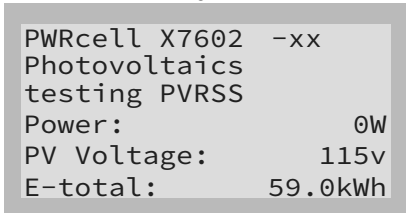

010033

Figure 6-5. PVRSS Commissioning (3 of 4)

- See [Figure 6-6](#). If installing a small number of PV modules on a substring such that the input voltage will not equal 135 VDC, select Vin Startup and lower the value as needed.

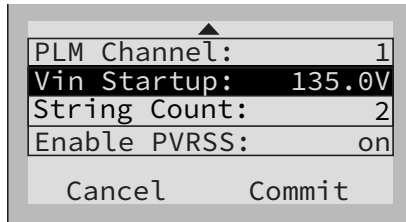

013778

Figure 6-6. PVRSS Commissioning (4 of 4)

- Complete steps 1 – 6 for each PV link in the system.

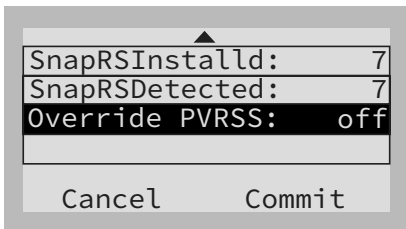

012943

Figure 6-7. SnapRS Check



WARNING

Ensure the following important safety settings are properly configured. Failure to properly configure PV Link with SnapRS could result in death, serious injury, or property damage.

(000754)

- Ensure that the “SnapRSInstalld” number is equal to the number of SnapRS physically installed on the associated PV Link.
- Ensure that “SnapRSDetected” matches the number of SnapRS physically installed on the associated PV Link.
- Never modify the count of “SnapRSInstalled” on a PV Link to a number other than the number physically installed to force operation.

NOTE: Using “Enable w/PVRSS” will force a SnapRS count and reset the “SnapRSInstalld” number, this should only be used by certified installers during initial commissioning.

Table 6-1. PV Link Settings

Setpoint	Range	Default	Description
PLM Channel	1–12	1	Channel for REbus communications. All devices in a system must use the same channel (except REbus Beacon).
Vin Startup	60–135 Volts	135 V	Minimum input voltage from the PV substring for the PV Link to make power.
String Count	1–2	1	Number of substrings plugged into the input of a PV Link. Set to a value of 2 if paralleling two series substrings for high voltage, 96 cell PV modules.
Enable PVRSS	on/off	off	Enables the photovoltaic rapid shutdown system (PVRSS). Turn this setting 'on' by selecting to 'Enable w/ PVRSS' if SnapRS are installed.
SnapRSIn-stalled	0–10	0	This is the number of SnapRS that are counted and stored upon the first successful count of SnapRS.
SnapRSDe-ctected	0–10	0	This is the number of SnapRS that are detected after each subsequent count. Counts occur daily.
Override PVRSS	on/off	off	This setting overrides a key feature of the PVRSS, closing the SnapRS devices without requiring a count. Do not leave override 'on.' Use only for temporary troubleshooting purposes.

Disabling PV Link

NOTE: Disabling a PV Link does NOT power down the PV array if SnapRS devices are not installed. If SnapRS devices are installed, array voltages are limited to less than 80 VDC once PV Link is disabled or its DC disconnect is opened.

NOTE: Disabling PV Link does not power down REbus if other devices are providing power to the DC bus.

NOTE: The disabled/enabled state of each PV Link persists through AC power outages and DC bus power cycling.

To disable a PV Link:

1. On the PWRcell Inverter control panel, use the left or right arrows to scroll to the page for the desired PV Link.
2. Press the center button to enter device settings.
3. Use the up and down arrows to highlight Disable and press the center button to select.
4. Arrow right and press the center button to Confirm.
5. Repeat steps 1 – 4 to disable any additional PV Links in the system.

NOTE: Repeat the process to re-enable each PV Link.

AFD Self-Test

NOTE: Arc fault detection is always enabled.

Performing an arc fault detection (AFD) self-test confirms arc fault detection functionality is working properly. When an arc fault is detected, the status message reads Arc Fault.

To conduct an AFD test:

1. On the PWRcell Inverter control panel, use the left or right arrow keys to scroll to the page for the desired PV Link.
2. Press the center button to access the device main menu.
3. Use the up and down arrows to highlight Test AFD and press the center button to enter the test state.
4. Arrow right and press the center button to Confirm

Upon test completion, the inverter control panel will display a result of Test Success or Test Failure. After a few seconds, the AFD test will automatically clear.

PVRSS Self-Test

After commissioning, you can verify proper function and configuration of the PVRSS system at any time by manually running the PV Link PVRSS self-test.

To run the PVRSS self-test:

1. On the PWRcell Inverter control panel press the right or left arrows keys to scroll to the desired PV Link.
- NOTE:** The device page display should read Disabled. If it does read not Disabled, press the center button and Disable the PV Link.
2. Press the center button to access the device main menu and select Test PVRSS to enter the Testing PVRSS state.

NOTE: The display will indicate Testing PVRSS during the test process, which can take up to three minutes. Upon successful completion, the display will read: Test Success. The PV Link will automatically re-enable.

This page intentionally left blank.

Section 7 Maintenance

CAUTION

Equipment damage. Never open the PV Link. The optimizer is factory-sealed and contains no field serviceable parts. Opening the optimizer could result in equipment damage. (000655a)

Maintenance

See [Figure 7-1](#). To ensure maximum performance, keep heatsink fins (A) free of leaves and other debris.

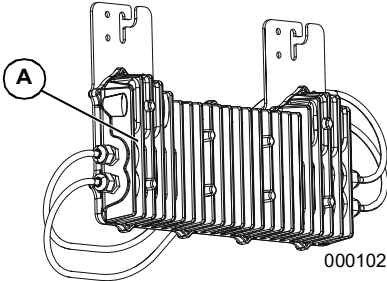

Figure 7-1. Heatsink Fins

The PV Link does not require regular maintenance and contains no user-serviceable parts.

Service

If the PV Link is not operating as expected, or if a PV Link error message appears on the Generac PWRcell Inverter control panel LCD display, contact the nearest Independent Authorized Service Dealer (IASD) or Generac Customer Service at 1-888-GENERAC (1-888-436-3722), or visit www.generac.com for assistance.

This page intentionally left blank.

Section 8 Troubleshooting

⚠ CAUTION

Equipment damage. Connect the PV Link output to a REbus-compatible device (\pm 190 VDC nominal regulated DC bus) only. Connecting to conventional PV inverters or any other device could cause equipment damage. (000659)

Table 8-1. PV Link Troubleshooting

Problem	Cause	Solution
Low Sun w/out SnapRS	PV Link does not have adequate input voltage. PV Links will show 'low sun' every night when the sun goes down or if PV modules are covered. Low sun when the sun is shining indicates a problem w/PV input. This is not a REbus wiring issue.	<ul style="list-style-type: none"> If few modules are installed and sub-string voltage is lower than 135 V, adjust Vin Startup value in mod. settings. Check PV Link Settings Measure Substring Voltage Check PV Wiring
Low Sun w/ SnapRS	PV Link does not have adequate input voltage. PV Links will show 'low sun' every night when the sun goes down or if PV modules are covered. Low sun when the sun is shining indicates a problem w/PV input. This is not a REbus wiring issue.	<ul style="list-style-type: none"> Ensure PV Link was enabled w/ PVRSS. If few modules are installed and sub-string voltage is lower than 135 V, adjust Vin Startup value in Mod. Settings Check PV Link Settings Measure Substring Voltage w/SnapRS Check PV Wiring SnapRS Health Check
No PV Link Device Comms	<ul style="list-style-type: none"> DC Disconnects are OFF for PV Links. Polarity is incorrect for REbus (+/-) between the PV Link and the inverter. PV Link has a poor ground connection to the inverter. One or more REbus DC fuses are blown at the inverter. 	<ul style="list-style-type: none"> Ensure DC Disconnect is ON. Check REbus Wiring Polarity. Check REbus Wiring Ground. <p>May Need to:</p> <ul style="list-style-type: none"> Check REbus Fuses.
Known PV Link 'Offline'	A PV Link that has communicated with the inverter previously shows 'offline' at its device page when it's connection to the inverter has been disrupted by: <ul style="list-style-type: none"> Opening the PV Link DC Disconnect Changing the PLM Channel on the PV Link so that it does not match the inverter. Compromising REbus wiring (+ / - / ground) 	<ul style="list-style-type: none"> Ensure DC Disconnect is ON Check PV Link Settings Check REbus Wiring <p>May need to:</p> <ul style="list-style-type: none"> Check REbus Fuses
PVRSS fail: high input	The voltage detected with SnapRS devices installed is higher than expected.	<ul style="list-style-type: none"> Verify the SnapRS devices are installed correctly. Run the PVRSS self-test. SnapRS devices have not been installed or have failed.
PVRSS not configured	PVRSS is enabled on the PV Link, but the SnapRSInstalld setting indicates no SnapRS devices are installed.	Follow the instructions in the PVRSS Commissioning with SnapRS Devices section. See Commissioning with SnapRS Devices for PVRSS .
PVRSS count mismatch	The number of SnapRS devices listed in the SnapRSInstalld does not match the number of SnapRSDetected.	Check the Mod. Settings menu and update the SnapRSInstalld value to reflect the number of installed SnapRS devices.
PVRSS fail: low input	The module output voltage is too low to accurately count the SnapRS devices.	If the failure occurs with normal exposure to sunlight, contact the nearest Independent Authorized Service Dealer (IASD) or Generac Customer Service at 1-888-436-3722 (1-888-GENERAC), or visit www.generac.com for assistance.

If the failure persists, contact the nearest Independent Authorized Service Dealer (IASD) or Generac Customer Service at 1-888-436-3722 (1-888-GENERAC), or visit www.generac.com for assistance.

SnapRS Health Check

There are no functional tests that can be performed on SnapRS devices in the field. However, some simple digital multimeter (DMM) checks can confirm the general health of a SnapRS device.

DMM Red to SnapRS +, DMM Black to SnapRS –

Resistance reads ~ 300 k Ω to 350 k Ω

Diode check reads ~ 0.45 V to 0.55 V

DMM Red to SnapRS –, DMM Black to SnapRS +

Resistance reads ~ 12 M Ω

NOTE: The values above assume use of a high-quality digital multimeter.

This page intentionally left blank.

This page intentionally left blank.

Part No. DMAN00013 Rev. D 02/18/2022

©2022 Generac Power Systems, Inc.

All rights reserved

Specifications are subject to change without notice.

No reproduction allowed in any form without prior
written consent from Generac Power Systems, Inc.

GENERAC[®]

Generac Power Systems, Inc.
S45 W29290 Hwy. 59
Waukesha, WI 53189

1-888-GENERAC (1-888-436-3722)

www.generac.com