

1) Splice, XR10, Mill 12" long

2) Screw, Self Drilling

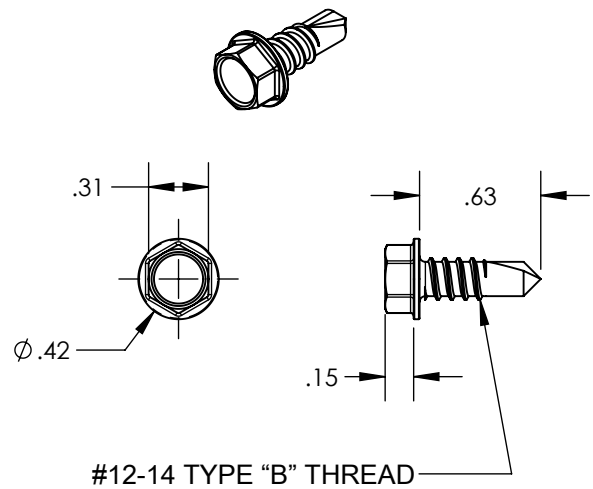
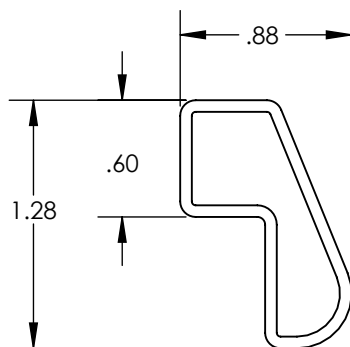

Property	Value
Material	6000 Series Aluminum
Finish	Mill

Property	Value
Material	300 Series Stainless Steel
Finish	Clear