

PART TABLE	
P/N	DESCRIPTION
004085M	FLASHLOC COMP KIT MILL, 20 PACK
004085D	FLASHLOC COMP KIT DARK, 20 PACK

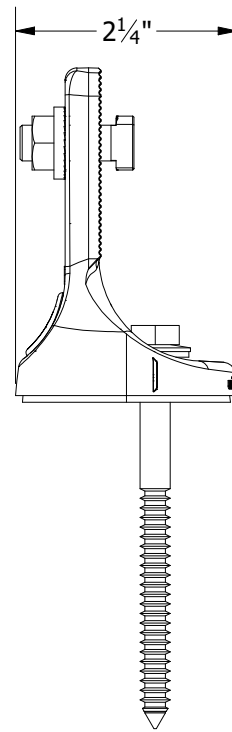
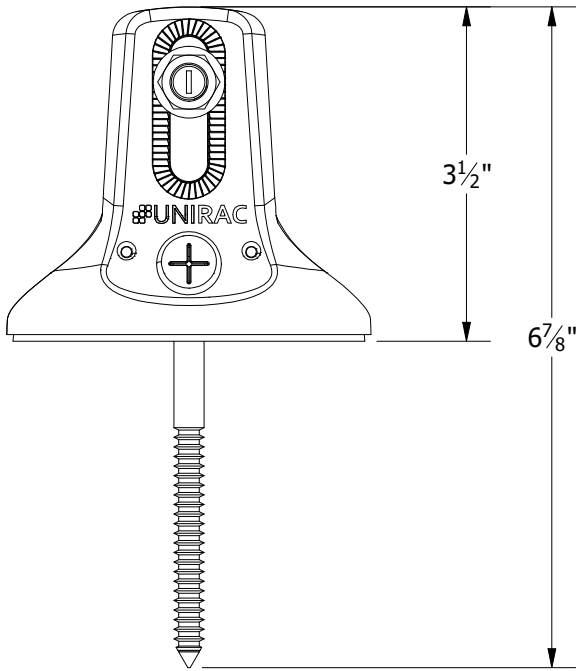
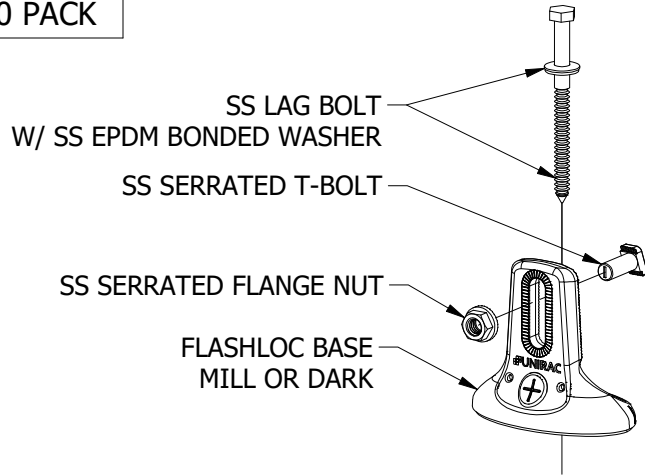
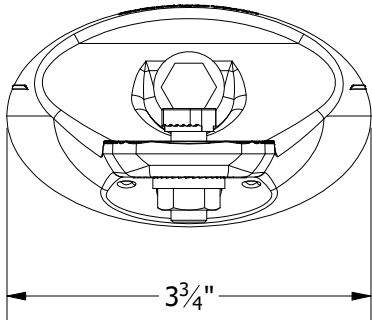

1411 BROADWAY BLVD. NE
ALBUQUERQUE, NM 87102 USA
PHONE: 505.242.6411
WWW.UNIRAC.COM

PRODUCT LINE:	SOLARMOUNT
DRAWING TYPE:	PART DRAWING
DESCRIPTION:	FLASHLOC COMP KIT
REVISION DATE:	10/3/2019

DRAWING NOT TO SCALE
ALL DIMENSIONS ARE
NOMINAL

PRODUCT PROTECTED BY
ONE OR MORE US PATENTS
LEGAL NOTICE

FL-A01

SHEET